

VI.AVI

VI.AVI Solutions

L3Harris XL Series™ Auto-Test and Alignment

8800SX Digital Radio Test Set



L3Harris Technologies XL Series Auto-Test and Alignment 8800SX Digital Radio Test Set

This guide describes how to setup and use the L3Harris XL Series Auto-Test application on the 8800SX.

Supported Models

XL-95P	XL-200P
XL-150P	XL-185M
XL-185P	XL-200M

Equipment Requirements

8800SX with options

- Option 04 – P25 Conventional Operation
- Option 117 – L3Harris XL Series Auto-Test and Alignment

Test Hardware

- VIAVI 82556 – 6 dB / 150 Watt 1.5 GHz Attenuator – For testing High Power mobiles
- Radio programming cable
 - L3Harris 12082-0415-A1 for XL-150P, XL-185P, XL-200P
 - L3Harris 14002-0174-50 or 14002-0174-71 for mobiles with USB to serial adapter
- Variable Power Supply
- Battery Eliminator (for portables)
 - L3Harris BT-023406-015 for XL-95P
 - L3Harris 14035-4300-01 for XL-150P, XL-185P, XL-200P
- Test Cable (Double Shielded RG-223 recommended) BNC (M) – BNC (M)
- Reference Cable (Short 6”) BNC (M) – BNC (M)
- 10 dB Attenuator BNC (M) – BNC (F) (Optional but recommended for best accuracy)
- Connector Adapters
 - BNC (F) – BNC (F)
 - BNC (F) – antenna L3Harris 19B801496G2 (for portables)
 - N (M) – BNC (F)

Before you Begin

- Before testing begins, be sure to check the system software version of your 8800. Select Utilities>Software>Update from the menu to see the installed system software version.
- The system version is indicated at the bottom right of the System Update screen, after the Model and Serial Number.

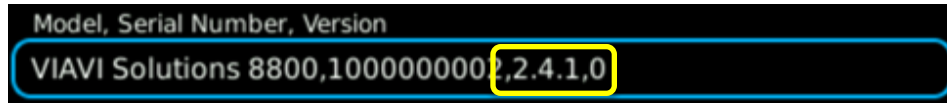

- The L3Harris XL application version is displayed in the Auto-Test screen with the Radio OEM.

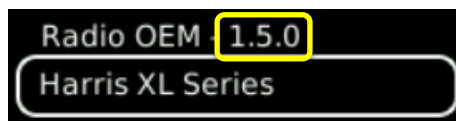

- Check for software updates on the VIAVI 8800 Series Software webpage at www.viavisolutions.com/en-us/software-download/8800-series-software. The current system software version is displayed next to 3920 Series Software Update.
- If your system software version is older than the version listed on this site, download the software, release notes, and installation instructions and update your system software. The system software download includes the latest Auto-Test Software Update.
- If the system software version is current, check your Auto-Test application version, as the test scripts are updated more frequently than system software. The Auto-Test Release Notes will list current versions in order of most recently updated.
- The Auto-Test Software Update includes all currently released test scripts.

XL Portable Interconnect

1. Connect a 7.5 VDC power supply to battery eliminator.
2. Connect radio ANT to 8800 T/R port
3. Connect radio programming cable using black USB connector to 8800 USB port.

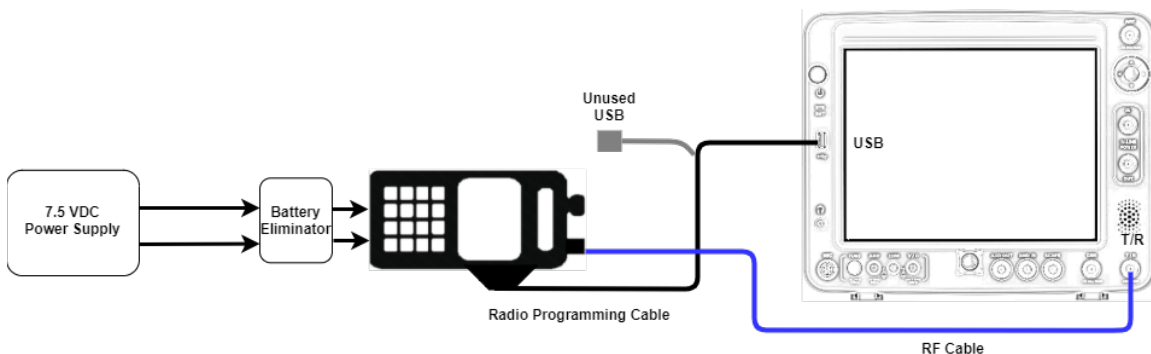

XL Mobile Interconnect

1. Connect 13.4 VDC power supply to radio.
2. Connect radio ANT connector to 8800 T/R port.
3. Connect radio programming cable to 8800 USB port with USB to RS-232 adapter.

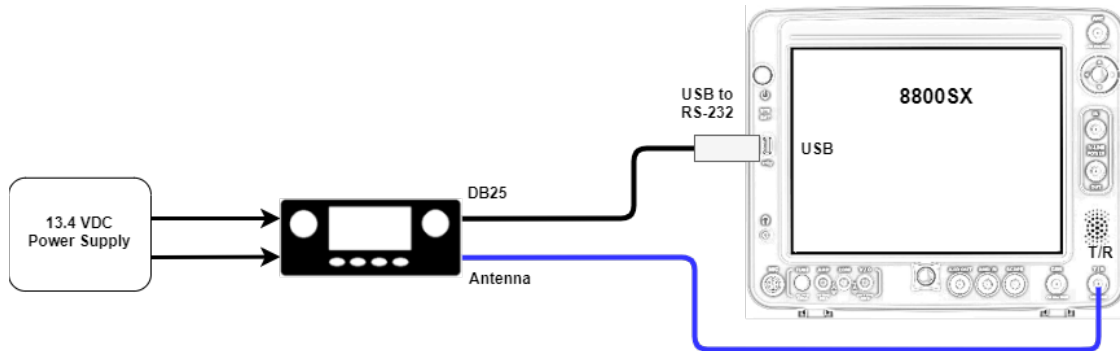

Access to the Application

1. Select the Utilities dropdown menu, then select Auto-Test.
2. Select Harris XL Series from the Radio OEM menu.

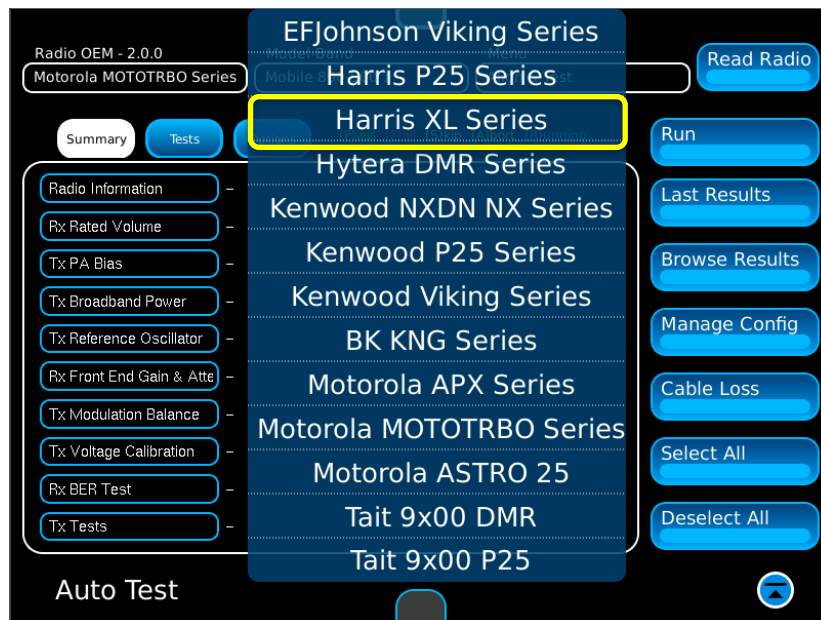

Test Screen – Function Keys

After selecting the Radio OEM, use the Read Radio button to query the radio. This will determine the model of the radio under test then display this information in the “Model-Band” field.

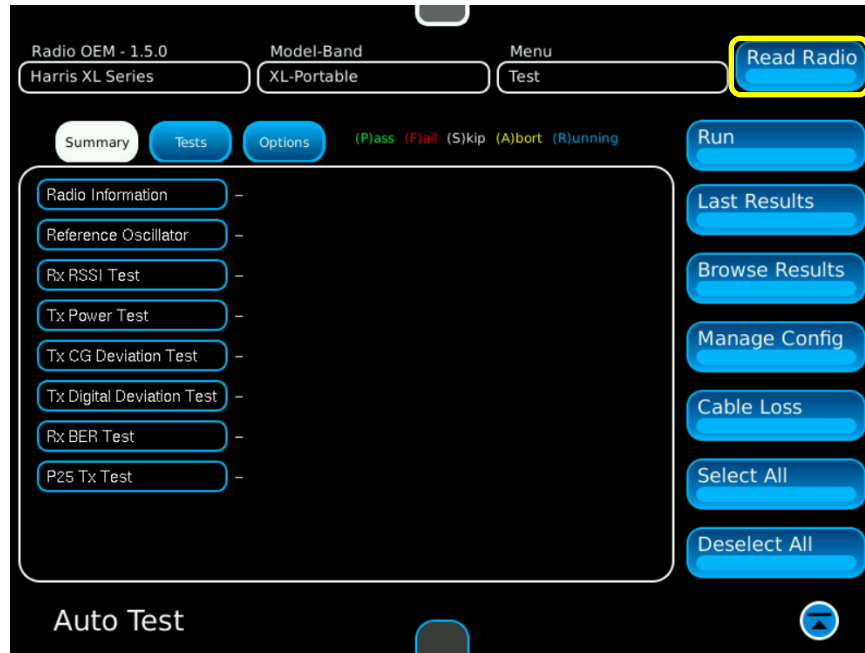

Run

- This will execute the selected test or alignment process.

Last Results

- Displays the test results of the last radio tested.

Browse Results

- Allows access to all previous results for all past radio tests.

Manage Config

- Store and Recall of user defined specification tables.

Cable Loss

- Allows the user to enter cable loss factors for separate frequency bands.

Select All

- Selects all tests available for the radio under test.

Deselect All

- Deselects all available tests.

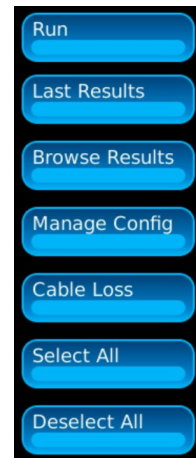

Note: All menu selections are maintained separately for each model as well as for the Align & Test and Test selection. It is important to either perform the Read Radio or select your model from the Model-Band menu prior to making test selections.

Test Screen – Test Selections



Summary

- Displays the Test Summary window showing current test conditions (P)ass (F)ail (S)kip (A)abort (R)unning.

Tests

- Displays the Test Configuration window allowing separate tests to be selected and configured. Some tests allow entry of test parameters. Available configurations may change between Test and Align & Test menu selections.
- Configure buttons allow access to specifications or other user entries.
- Configure for Radio Information allows three lines of user text to be entered that will be visible at the beginning of the printout in the Test Results file. These could be used to identify a Technician ID, Company Name or anything that might be useful at the beginning of the printout.

Options

- The Options tab will display the Options window allowing the user to configure various items. Along with selecting the frequency bands to be tested or aligned.

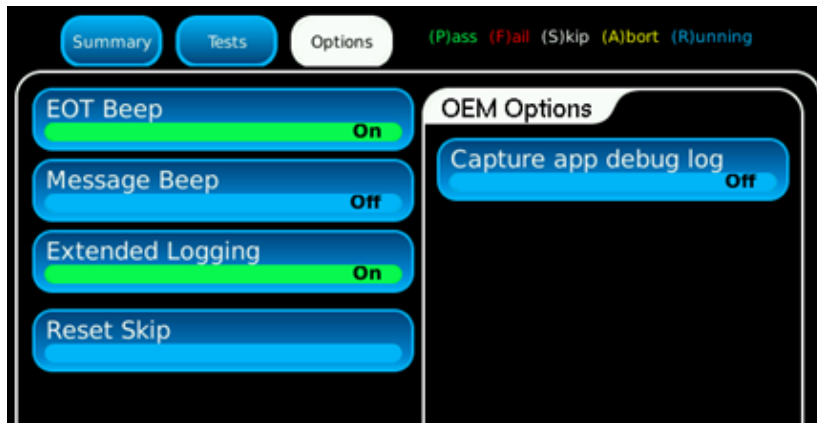

EOT Beep

- The 8800SX will produce an audible beep at the completion of all tests and alignments to notify the operator that the test or alignment is done.

Message Beep

- When testing dual band mobiles, you will be prompted to move the test cable when moving from one band connector to the other. This option will produce an audible beep to prompt the operator to change the cable connection. Note: The highest frequency band that is selected is always tested first.

Extended Logging

- Diagnostic mode that shows all adjustments to soft pot values.

Reset Skip

- Some mobiles require this setting to be enabled. It does not cause any issue to have it selected for other radios.

L3Harris Technologies XL Series Auto-Test and Alignment 8800SX Digital Radio Test Set

OEM Options

- Capture app debug log – Will create a log file for diagnostic purposes.

Cable Loss Basics

Every coaxial cable has a loss associated with it. If extremely short, the loss may be negligible. However, any loss that is not compensated will have an effect on radio measurements. For example, a 4' length of RG-58, used to test a 50 watt mobile radio at 800 MHz will impart an error of approximately 0.7 dB. While this seems insignificant, when converted to a percentage, its importance becomes clear. That 50 watt mobile is actually transmitting almost 60 watts!

- To eliminate this error, compensation must take place.
- The following pages show how to measure the cable loss for a coaxial cable used to test a radio, but the same procedure can be used for measuring insertion loss of attenuators and other devices, as well.

Cable Loss Calibration

1. On the 8800, press the home button to access the System Menu. Select the “Sys Reset” button and select “Yes” when you receive the prompt: “Do you want to restore factory defaults?”

Note: This will not delete any user files.



From the Utilities Menu, select Presets -> Clear Display to remove any tiles that may have been previously displayed.

Note: Touch the grey bar at the top to access the menu bar.

2. Select the following tiles to be displayed:
 - Generators – Generator
 - Receivers – Receiver
 - Meters – RSSI

**L3Harris Technologies XL Series Auto-Test and Alignment
8800SX Digital Radio Test Set**

3. Maximize the Generator and Receiver Tiles.
4. Configure the RF Generator Tile.
 - Port: GEN
 - Enable: ON
 - Level: -12 dBm
5. Configure the RF Receiver Tile.
 - Frequency: 136.125 MHz
 - Gen Offset: 0.00 MHz
 - Lock: ON
 - IF BW: 10 kHz
 - Port: ANT
 - AGC: Auto

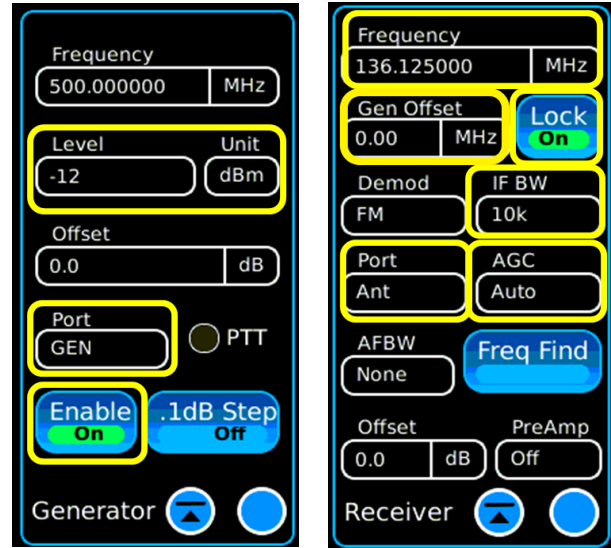

6. Connect Type N adapters to 8800 GEN and ANT ports.
7. Connect the 10 dB Attenuator to the N adapter on the 8800 ANT port.
8. Connect the Reference cable from the 8800 GEN port to the attenuator on the 8800 ANT port.

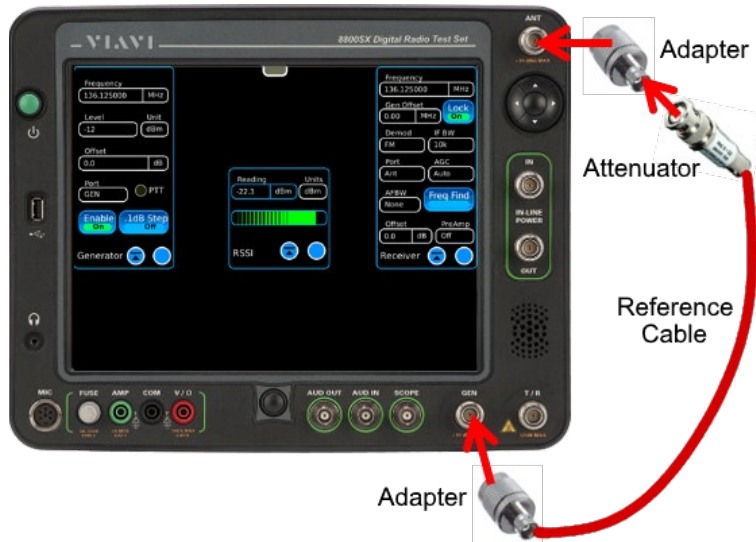

9. Note the level displayed on the RSSI Meter. Example: -22.3 dBm

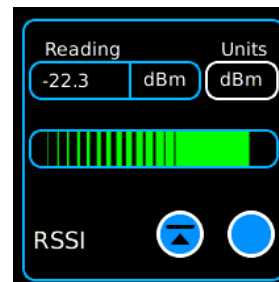

**L3Harris Technologies XL Series Auto-Test and Alignment
8800SX Digital Radio Test Set**

10. Set the Receiver Tile AGC setting from auto to manual.
 - This value should be the next higher value than what is indicated by the RSSI meter. Setting the AGC to a fixed range prevents automatic ranging from choosing a different setting. For -22.3 dBm, set AGC to -20 dBm.

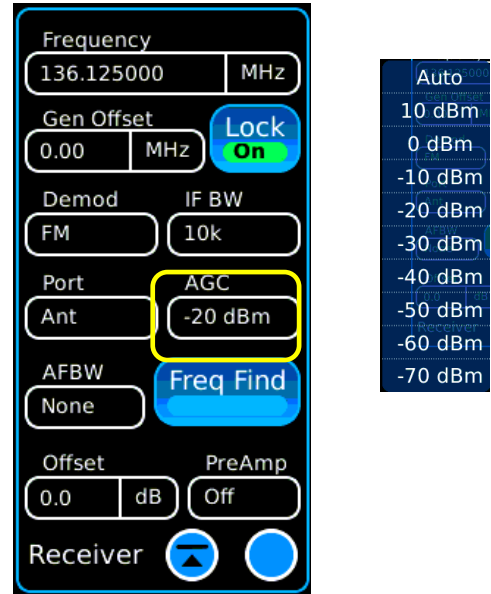

11. Establish a zero dB Reference (dBr).
 - Change the RSSI Meter units control from dBm to dBr.
 - Note that the meter now reads 0.00 dBr.



13. Add the Test cable in-line with the Reference cable.
 - Disconnect the Reference cable from the 10 dB Attenuator on the 8800 ANT port. (Leave the attenuator on the 8800 ANT port.)
 - Using a BNC barrel connector, connect the Test cable to the Reference cable as shown.
 - Connect the other end of the Test cable to the 10 dB Attenuator on the 8800 ANT port.



14. Record the measured Cable Loss of the Test Cable.
 - RSSI meter now indicates the amount of insertion loss of the Test cable at this frequency.
 - Record the Loss factor for this frequency.
 - Set the RSSI Meter Units back to dBm.
15. Repeat steps 9 through 14 for the following frequencies:
 - 440.125 MHz
 - 810.125 MHz

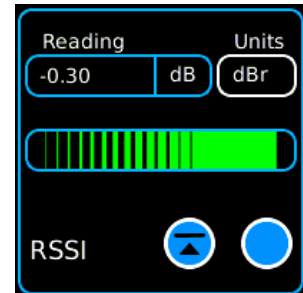

Cable Loss Entry

1. Access the Auto-Test application and select the Cable Loss function button.
2. Enter the recorded Loss values into the appropriate frequency band areas on the Cable Loss screen.

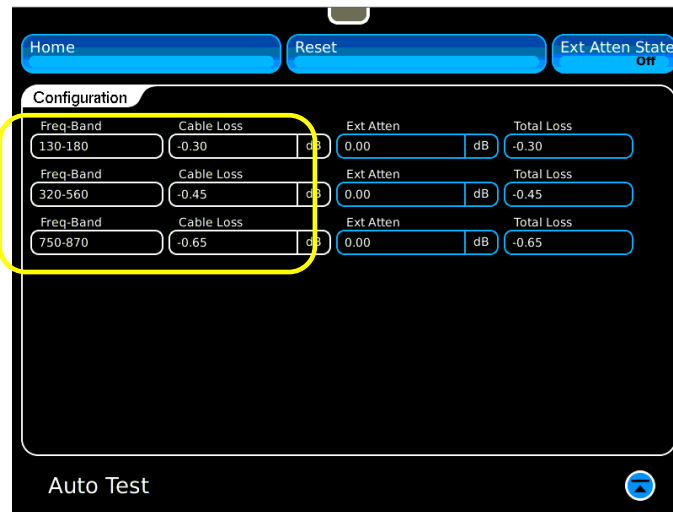

3. Select Home when finished to return to the Auto-Test screen.
4. The cable calibration is now complete. The Auto-Test application will use the entered values to correct the measured power meter readings by the amount of the cable loss.

Test and Align & Test Functions

Test Function

- When selected, the menu will change to show only Test items.
- No alignments will be made. A test report of pass/fail results will be recorded. Radio model will be automatically identified, and the appropriate specification table will be used for testing.

Align & Test Function

- All selected items that are capable of being aligned will be aligned. Performance tests will also be performed to validate the alignment.

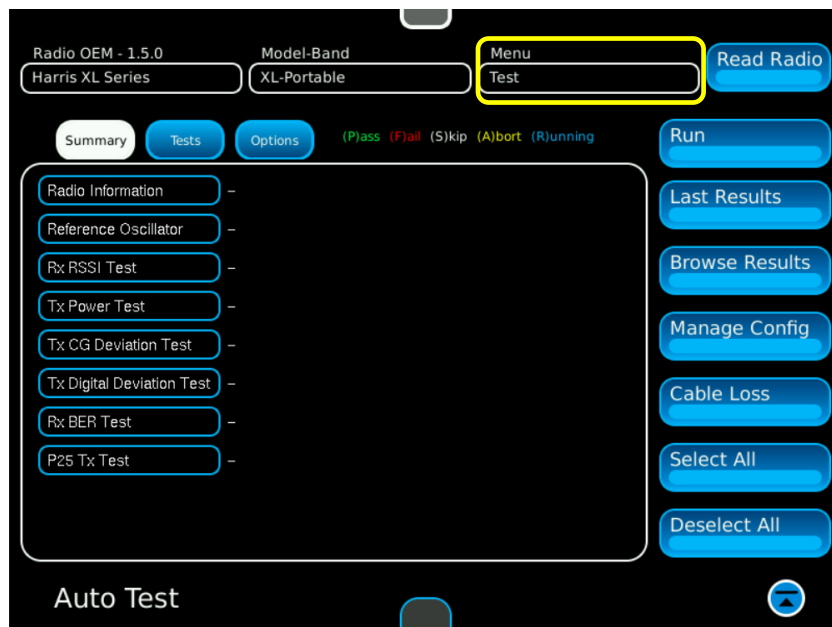

Select All

- This will enable all tests.

Deselect All

- This will disable all tests.

Last Results

Displays the most recently completed test result.

- Shows Time Date stamp along with the 8800's serial number and version information for both the system and the application.
- Shows radio model, serial number along with radio software versions and configurations.
- Shows the Flash Code

Select Home to return to the Auto-Test screen.

Press the  icon to exit the Auto-Test screen.

Browse Results

Shows all test result files for the current Auto-Test application.

Select

- Allows a test results file to be loaded and displayed.

Copy to USB

- Copies ALL test result files for the current Auto-Test application to a connected USB memory stick.
- After inserting the USB stick, wait several seconds (or until its light stops flickering on the drive) before selecting Copy to USB.
- Be sure to leave the USB stick in long enough for the file copy to complete, waiting 15-20 seconds after the completion message appears.
 - Removing the USB stick early may result in files not being copied to the memory stick successfully or showing as empty (0 kB in size).

Delete All

- Deletes ALL test result files for the current Auto-Test application.

Running the Auto-Test, Step by Step

1. Select Auto-Test from the Utilities menu and select Harris XL Series from the Radio OEM list.
2. Connect the Portable or Mobile radio to be tested.
3. Select Read Radio.
 - Check that there are Loss values entered in the Cable Loss Screen for the bands being tested.
 - If Loss values are not entered, then perform the Cable Loss Calibration procedure.
4. Select Test or Align & Test from the menu.
5. From the Tests Tab, choose all individual tests to be performed.
6. Press Run to begin the Test or Alignment.
7. Failed tests should be confirmed by re-testing.